

AllmandTM

NIGHT-LITE

6330 AND 8330 OPERATOR'S MANUAL

**ALLMAND BROS. INC
P.O. BOX 888
HOLDREGE, NE 68949**

**PHONE: 308/995-4495, 1-800/562-1373
ALLMAND FAX: 308/995-5887
ALLMAND PARTS FAX: 308/995-4883**

AllmandTM **NIGHT-LITE SERIES**

For Parts and Updates visit Allmand on the Web at www.allmand.com

INSPECTION CHECK LIST

FOR PREPARING THE NIGHT-LITE 6330 FOR DELIVERY OR RENTAL

The **NIGHT-LITE 6330** requires service as well as proper operation in order to provide the performance and safety it has been designed for. Never deliver or put a machine into service with known defects or missing instructions or decals. Always instruct the customer in the proper operation and safety procedures as described in the operator's manual. Always provide the manual with the equipment for proper and safe operation.

CHECK LIST:

- Visually inspect the equipment to ensure that all instructions and decals are in place and legible.
- Inspect the tower latch and knob assembly which locks the tower in the vertical position for proper operation
- Check the hitch assembly and safety tow chains
- Check the outriggers and jacks to make sure they operate properly
- Inspect the light assemblies for damage and test for proper operation
- Inspect the electrical wiring for signs of damage
- Check the ground rod cable and the ground lug. Make sure they are clean, undamaged, and functional.
- Inspect the tires to ensure good condition and proper inflation
- Check oil, fuel, coolant levels, and hydraulic fluid levels.
- Check to make sure the operator's manual is with the equipment.
- Inspect the machine physically for damage and repair if necessary.

NOTE: See appropriate section of manual for scheduled maintenance intervals.

After completing the inspection check list, operate the tower through a complete operation cycle, following the operating instructions in the operator's manual.



WARNING

**NEVER ALLOW ANYONE TO OPERATE THE EQUIPMENT WITHOUT
PROPER TRAINING!**

ALWAYS READ THE INSTRUCTIONS FIRST!

TABLE OF CONTENTS

INSPECTION CHECK LIST	2
TABLE OF CONTENTS	3
INTRODUCTION	4
SAFETY SYMBOL INFORMATION	4
SAFETY AND WARNING DECALS	5-7
MANUAL WINCH MAST OPERATION	8-9
ELECTRIC WINCH MAST OPERATION	10-11
SPECIFICATIONS	12-13
SERIAL NUMBER LOCATION	14
SPECIFICATIONS	15-17
CONTROLS AND COMPONENTS	18-25
ROUTINE MAINTENANCE SCHEDULE	26
LISTER-PETTER LPW-3	
ROUTINE MAINTENANCE SCHEDULE	27
KUBOTA D905 D1105 AND PERKINS 103-10	
TROUBLESHOOTING	28
ASSEMBLY PARTS AND ACCESSORIES	29

INTRODUCTION

- This manual provides the information necessary for the safe operation of the Allmand Bros., Inc., **NIGHT-LITE 6330** light tower.
- The **NIGHT-LITE 6330** standard tower configuration is operated by a two manual crank winches or single electric winch used to erect, extend, and lower the tower.
- Specific operating instructions and specifications are contained in this publication to familiarize the operator and maintenance personnel with the correct and safe procedures necessary to maintain and operate the equipment.

Take time to read this book thoroughly. If you are uncertain about any of the information presented in the manual, contact the factory or your dealer for clarification before operation.

SAFETY SYMBOLS

The purpose of the **SAFETY INFORMATION SYMBOL** shown below is to attract your special attention to safety related information contained in the text.



FAILURE TO UNDERSTAND AND COMPLY WITH SAFETY RELATED INFORMATIONAL INSTRUCTIONS MAY RESULT IN INJURY TO OPERATOR OR OTHERS. IF YOU DO NOT UNDERSTAND ANY PART OF THIS INFORMATION CONTACT YOUR DEALER FOR CLARIFICATION PRIOR TO OPERATING EQUIPMENT.

NOTE

The word **NOTE** is used to bring your attention to supplementary information in relation to various aspects of proper operation and maintenance.

NOTE: Keep this manual accessible during operation to provide convenient reference.

NOTE: Any reference in this manual to **LEFT** or **RIGHT** shall be determined by looking at the trailer from the rear.

SAFETY AND WARNING DECALS

SAFETY WARNING

ALWAYS REPLACE ANY SAFETY AND INSTRUCTION DECALS THAT BECOME DAMAGED, PAINTED, OR OTHERWISE ILLEGIBLE.

Refer to these representations of the safety warning decals used on the MAXI-LITE to insure correct ordering if replacing becomes necessary.

OPERATING INSTRUCTIONS
Read and understand Operator's Manual before operating machine.

BEFORE STARTING:

1. Visually inspect machine for leaks or damage.
2. Make sure battery connections are clean and tight.
3. Check engine oil level (see manual).
4. Check fuel supply (see manual).
5. Check air cleaner, seals, hoses and clamps (see manual).

STARTING:

1. Turn off all circuit breakers.
2. Turn ON/OFF toggle switch to up (ON) position.
3. Press and hold PREHEAT switch (below 30 °F, hold for 1 minute before adding step 4).
4. Press START switch while holding PREHEAT switch in. Release both switches as soon as engine starts.

NOTE: Do not crank for more than 10 seconds without allowing starter to cool for 30 seconds.

STOPPING:

1. Turn lights off with circuit breakers.
2. Unplug external leads.
3. Turn ON/OFF toggle switch to down (OFF) position.

CAUTION
MAKE SURE GROUND ROD IS PUT AWAY AND JACKS, OUTRIGGERS AND MAST ARE FULLY RETRACTED AND LOCKED INTO PLACE BEFORE TOWING.

D-151

PART NO. D-151
Location: Inside left hand door panel of Lister Petter engine units.

OPERATING INSTRUCTIONS
Read and understand Operator's Manual before operating machine.

BEFORE STARTING:

1. Visually inspect machine for leaks or damage.
2. Make sure battery connections are clean and tight.
3. Check engine oil level (see manual).
4. Check fuel supply (see manual).
5. Check air cleaner, seals, hoses and clamps (see manual).

STARTING:

1. Turn off all circuit breakers.
2. Turn switch to Preheat position, hold until the glow plug lamp goes out.
3. Turn switch to start position until the engine starts. Release key as soon as the engine starts.
4. If engine fails to start, repeat cycle.

NOTE: Do not crank for more than 10 seconds without allowing starter to cool for 30 seconds.

STOPPING:

1. Turn lights off with circuit breaker.
2. Unplug external leads.
3. Turn ON/OFF toggle switch to down (OFF) position.

CAUTION
MAKE SURE GROUND ROD IS PUT AWAY AND JACKS, OUTRIGGERS AND MAST ARE FULLY RETRACTED AND LOCKED INTO PLACE BEFORE TOWING.

D-249

PART NO. D-249
Location: Inside left hand door panel of Kubota engine units.

LIFTING INSTRUCTIONS

CAUTION
A MINIMUM OF 2 TONS LIFTING CAPACITY IS REQUIRED TO LIFT THIS MACHINE!

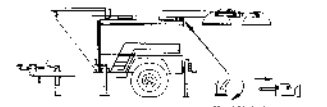

Mast Hold-down Pin

BEFORE LIFTING:

1. Make sure the mast hold-down pin (shown above) is fully inserted and secure to lock the mast in place.
2. Unplug all external equipment and move it a safe distance away.
3. Clear the machine of all loose objects.

WARNING!
LIFTING heavy equipment is a dangerous activity. Do not allow personnel on or near the machine and keep all bystanders a safe distance away. Failure to follow these instructions could result in severe injury or death.

D-264

PART NO. D-264
Location: Inside left hand door panel.

ERECT MAST & RAISE LIGHTS

1. LIFT MAST BY RAISING MAST JACKS.
2. CONNECT GROUND ROD AND MAKE SURE TIGHT.
3. TURN ON/OFF SWITCH UP.
4. TURN ON/OFF SWITCH UP.
5. TURN ON/OFF SWITCH UP AND HOLD FOR 10 SECONDS.
6. LIFT MAST TO 45 DEGREES.

LOWER MAST

1. LOWER MAST BY RAISING MAST JACKS.
2. DISCONNECT GROUND ROD AND MAKE SURE TIGHT.
3. TURN ON/OFF SWITCH DOWN.
4. TURN ON/OFF SWITCH DOWN.
5. TURN ON/OFF SWITCH DOWN AND HOLD FOR 10 SECONDS.
6. LOWER MAST TO 15 DEGREES.

D-259

PART NO. D-259
Location: Inside left hand door panel. Manual winch model only.

ERECT MAST & RAISE LIGHTS

1. LIFT MAST BY RAISING MAST JACKS.
2. CONNECT GROUND ROD AND MAKE SURE TIGHT.
3. TURN ON/OFF SWITCH UP.
4. TURN ON/OFF SWITCH UP.
5. TURN ON/OFF SWITCH UP AND HOLD FOR 10 SECONDS.
6. LIFT MAST TO 45 DEGREES.

LOWER MAST

1. LOWER MAST BY RAISING MAST JACKS.
2. DISCONNECT GROUND ROD AND MAKE SURE TIGHT.
3. TURN ON/OFF SWITCH DOWN.
4. TURN ON/OFF SWITCH DOWN.
5. TURN ON/OFF SWITCH DOWN AND HOLD FOR 10 SECONDS.
6. LOWER MAST TO 15 DEGREES.

D-262

PART NO. D-262
Location: Inside left hand door panel. Electric winch model only.

SAFETY AND WARNING DECALS

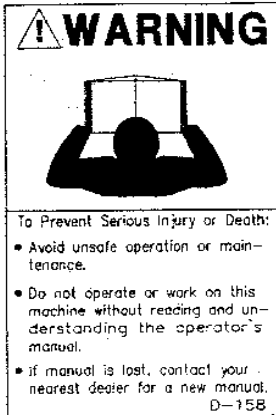

PART NO. D-158
Location: AC control panel

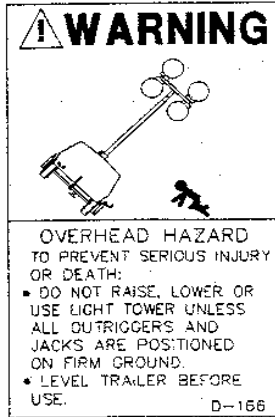

PART NO. D-166
Location: inside left hand door panel

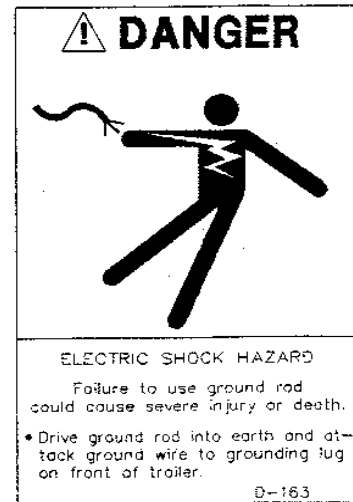

PART NO. D-163
Location: On left side wheel well

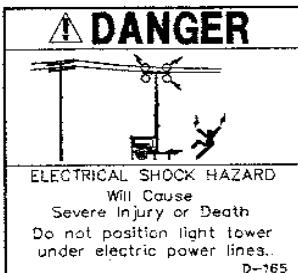

PART NO. D-165
Location: Inside left hand door panel

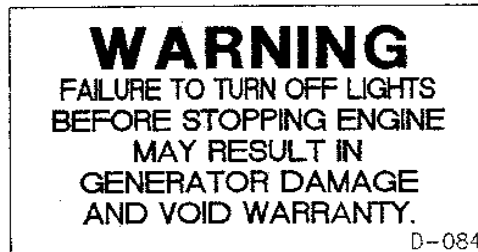

PART NO. D-084
Location: AC control panel

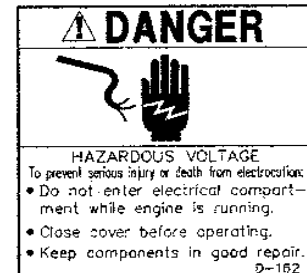

PART NO. D-162
Location: On left front ABS panel



PART NO. D-133
Location: On left side panel below ground lug

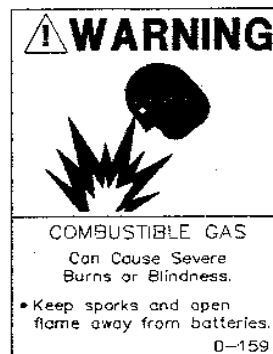

PART NO. D-159
Location: On right hand wheel well

SAFETY AND WARNING DECALS

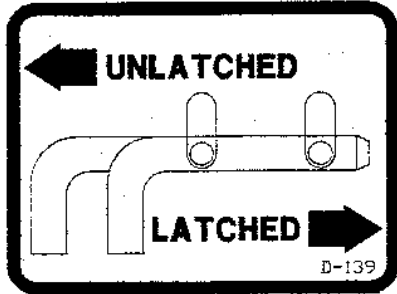

PART NO. D-139
Location: On rear panel under the rear tower support.

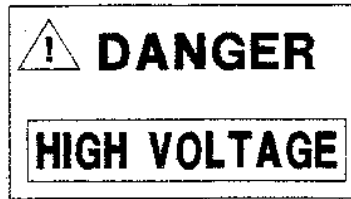

PART NO. D-002
Location: Light bar cover

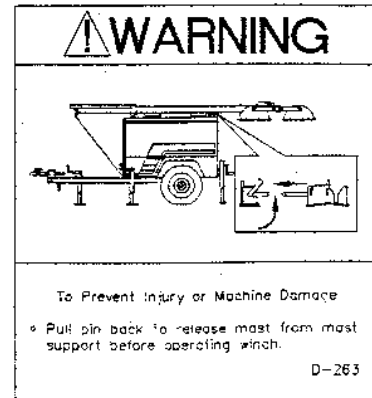

PART NO. D-263
Location: Inside left hand door panel

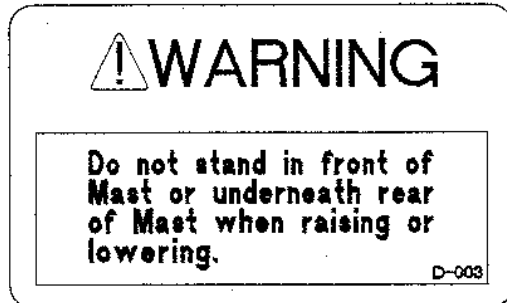

PART NO. D-003
Location: Inside left hand door panel

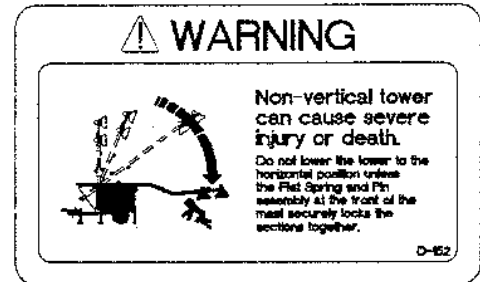

PART NO. D-152
Location: Inside left hand door panel

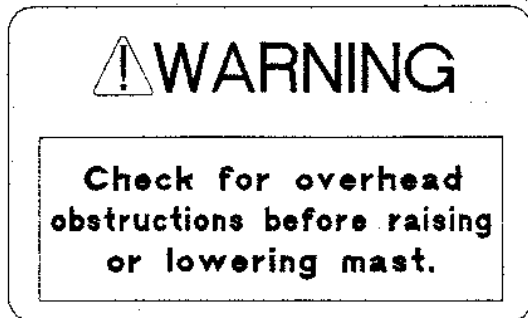

PART NO. D-005
Location: Inside left hand door panel

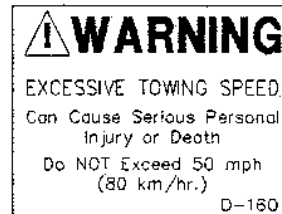

PART NO. D-160
Location: On pintle hitch

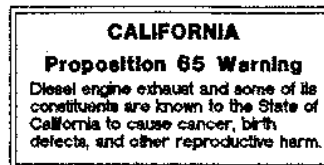

PART NO. D-179
Location: Inside left hand door panel

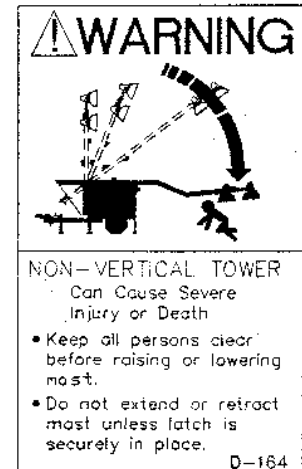

PART NO. D-164
Location: On mast pivot section

MANUAL WINCH MAST OPERATION

DESCRIPTION OF OPERATION

The Allmand **NIGHT-LITE 6330** tower assembly consists of a three section telescoping mast which can be raised and extended by operating two hand crank winches. One winch, mounted with the handle extending through the side of the trailer frame, raises and lowers the mast from the horizontal towing position, the vertical position, and back. The second winch mounted on the tower extends the telescopic sections.

The three section mast assembly can be rotated from the ground by loosening a knob and rotating the entire assembly 360° to aim the lights as necessary.



SAFETY WARNING

- ALWAYS CHECK FOR OVERHEAD OBSTRUCTIONS BEFORE RAISING AND LOWERING MAST. ALLOW 35' CLEARANCE. AVOID ALL OVERHEAD ELECTRICAL WIRES.
- TO PREVENT INSTABILITY AND HELP ENSURE SAFE OPERATION, ALWAYS PROVIDE PROPER GROUND SUPPORT BEFORE RAISING MAST.
- BEFORE RAISING MAST, VISUALLY INSPECT EQUIPMENT FOR DAMAGE OR WEAR. FAMILIARIZE YOURSELF WITH THE LOCATION AND FUNCTION OF ALL OPERATING PARTS BY STUDYING THIS MANUAL. OBSERVE ALL CAUTION DECALS LOCATED ON EQUIPMENT

NOTE: The latch locks the mast in the vertical position and disengages the sections allowing the tower assembly to be rotated to position the lights.

TO ERECT MAST AND RAISE LIGHTS

1. Extend both side outrigger jacks, rear jack and tongue jack to stabilize and level the trailer.

NOTE: Jacks should be placed only on firm footing.



SAFETY WARNING

- WHEN EXTENDING REAR JACK, WATCH TO ENSURE YOU ARE CLEAR OF THE OVERHANGING ENDS OF THE MAST BEFORE YOU STAND UP.
 - THE SUPPLEMENTAL GROUND ROD IS A SAFETY DEVICE THAT MAY REDUCE THE CHANCE OF PERSONAL INJURY FROM STRAY ELECTRICAL CURRENT. Therefore, Allmand recommends using the ground rod. However, it is the user's responsibility to determine the requirements and/or applicability of local, state, or national electrical code which governs the use of the ground rod.
2. Attach the ground rod to the grounding lug, and drive the ground rod fully for adequate electrical ground, as required by local, state, or national code.
 3. Release the pin that secures the mast to the rear mast support.
 4. Operate the hand crank on the side of the trailer to raise the mast from horizontal to vertical.
 5. Turn black knob counterclockwise and engage latch in strike plate. Retighten black knob.
 6. Operate the hand crank winch on the tower clockwise to raise the lights vertically.
 7. To rotate the lights, release the black knob and turn the tower assembly with the handles provided.
 8. To turn on lights, flip the breaker switches to the up position. (SEE FIG. 1)

MANUAL WINCH MAST OPERATION



SAFETY WARNING

- IF THE TOWER CANNOT BE ROTATED AFTER LOOSENING THE BLACK KNOB, CHECK TO ASSURE THE LOWER LATCH IS ENGAGED IN THE STRIKE PLATE. THIS DOUBLE LATCH FEATURE PREVENTS THE TOWER FROM BEING ROTATED IF THE LATCH IS NOT ENGAGED.



SAFETY WARNING

VISUALLY INSPECT EQUIPMENT FOR DAMAGE BEFORE OPERATING. ALLOW ADEQUATE CLEARANCE AROUND TRAILER FOR TOWER AND INSURE THAT NO PERSONS ARE STANDING IN FRONT OF OR BEHIND UNIT WHEN LOWERING.

TO LOWER MAST AND LIGHTS

1. Turn off lights.
2. Release black knob and rotate tower until winch handle points to the front of the trailer and retighten knob.
3. Operate hand crank winch on tower counterclockwise to lower the lights to the lowest vertical position
4. Operate hand crank winch on side of trailer clockwise to take up any cable slack.
5. Turn the black knob counterclockwise and lift to release the latch from the strike plate. Retighten the knob with the latch disengaged from the strike plate.

6. Operate the hand crank on the side of the trailer counterclockwise to fold the mast down into the towing position.

NOTE: Sufficient load (75 lb. min) must be applied to the cable to overcome internal resistance and operate the brake properly. Insufficient load will not turn the reel thus continual turning without sufficient load will remove the winch handle from the shaft.

7. Secure light cords into hook on the rear tower support for towing.
8. Secure pin locking mast to rear tower support.
9. Remove ground rod from earth. Disconnect wire from ground lug and secure in trailer
10. Raise jacks and rear stand, retract outriggers and secure for towing

NOTE: Ensure the detent pins are properly engaged in the outriggers before towing.

NOTE: Visually inspect the flood light mounting yokes for loose hardware. This could prevent a broken fixture during towing.

STRONG ARM ELECTRIC WINCH MAST OPERATION

DESCRIPTION OF OPERATION

The Allmand **NIGHT-LITE 6330** tower assembly consists of a three section telescoping mast which can be raised and extended by operating a single electric winch mounted inside the enclosure. A single three position toggle switch mounted on the control panel is used to raise and lower the mast. The winch and cable are protected by an integral clutch and a circuit breaker. The clutch is designed to slip when the mast reaches full extension. The circuit breaker is a safeguard for the clutch. If the clutch is misadjusted or inoperative the circuit breaker should trip to protect the system from overload. The electric winch operates off the 120 volt circuit breaker along with 120 volt receptacle thus requiring **that the 120 volt circuit breaker switch must be on to operate the winch.**

The three section mast assembly can be rotated from the ground by loosening a knob and rotating the entire assembly 360° to aim the lights as necessary.



SAFETY WARNING!

- **ALWAYS CHECK FOR OVERHEAD OBSTRUCTIONS BEFORE RAISING AND LOWERING MAST. ALLOW 35' CLEARANCE. AVOID ALL OVERHEAD ELECTRICAL WIRES.**
- **TO PREVENT INSTABILITY AND HELP ENSURE SAFE OPERATION, ALWAYS PROVIDE PROPER GROUND SUPPORT BEFORE RAISING MAST.**

NOTE: The latch locks the mast in the vertical position and disengages the sections allowing the tower assembly to be rotated to position the lights

BEFORE RAISING MAST, VISUALLY INSPECT EQUIPMENT FOR DAMAGE OR WEAR. FAMILIARIZE YOURSELF WITH THE LOCATION AND FUNCTION OF ALL OPERATING PARTS BY STUDYING THIS MANUAL. OBSERVE ALL CAUTION DECALS LOCATED ON EQUIPMENT

TO ERECT MAST AND RAISE LIGHTS

1. Extend both side outrigger jacks, rear jack and tongue jack to stabilize and level the trailer.

NOTE: Jacks should be placed only on firm footing.



SAFETY WARNING

- **WHEN EXTENDING REAR JACK, WATCH TO ENSURE YOU ARE CLEAR OF THE OVERHANGING ENDS OF THE MAST BEFORE YOU STAND UP.**
 - **THE SUPPLEMENTAL GROUND ROD IS A SAFETY DEVICE THAT MAY REDUCE THE CHANCE OF PERSONAL INJURY FROM STRAY ELECTRICAL CURRENT. Therefore, Allmand recommends using the ground rod. However, it is the user's responsibility to determine the requirements and/or applicability of local, state, or national electrical code which governs the use of the ground rod.**
2. Attach the ground rod to the grounding lug, and drive the ground rod fully for adequate electrical ground, as required by local, state, or national code.
 3. Release the pin that secures the mast to the rear mast support.
 4. Operate the hand crank on the side of the trailer to raise the mast from horizontal to vertical.
 5. Turn black knob counterclockwise and engage latch in strike plate. Retighten black knob.
 6. Operate the hand crank winch on the tower clockwise to raise the lights vertically.
 7. To rotate the lights, release the black knob and turn the tower assembly with the handles provided.
 8. To turn on lights, flip the breaker switches to the up position. (SEE FIG. 1)

STRONG ARM ELECTRIC WINCH MAST OPERATION



SAFETY WARNING

- IF THE TOWER CANNOT BE ROTATED AFTER LOOSENING THE BLACK KNOB, CHECK TO ASSURE THE LOWER LATCH IS ENGAGED IN THE STRIKE PLATE. THIS DOUBLE LATCH FEATURE PREVENTS THE TOWER FROM BEING ROTATED IF THE LATCH IS NOT ENGAGED.



SAFETY WARNING

VISUALLY INSPECT EQUIPMENT FOR DAMAGE BEFORE OPERATING. ALLOW ADEQUATE CLEARANCE AROUND TRAILER FOR TOWER AND INSURE THAT NO PERSONS ARE STANDING IN FRONT OF OR BEHIND UNIT WHEN LOWERING.

TO LOWER MAST AND LIGHTS

1. Turn off lights.
2. Release black knob and rotate tower until winch handle points to the front of the trailer and retighten knob.
3. Operate hand crank winch on tower counterclockwise to lower the lights to the lowest vertical position
4. Operate hand crank winch on side of trailer clockwise to take up any cable slack.
5. Turn the black knob counterclockwise and lift to release the latch from the strike plate. Retighten the knob with the latch disengaged from the strike plate.

6. Operate the hand crank on the side of the trailer counterclockwise to fold the mast down into the towing position.

NOTE: Sufficient load (75 lb. min) must be applied to the cable to overcome internal resistance and operate the brake properly. Insufficient load will not turn the reel thus continual turning without sufficient load will remove the winch handle from the shaft.

7. Secure light cords into hook on the rear tower support for towing.
8. Secure pin locking mast to rear tower support.
9. Remove ground rod from earth. Disconnect wire from ground lug and secure in trailer
10. Raise jacks and rear stand, retract outriggers and secure for towing

NOTE: Ensure the detent pins are properly engaged in the outriggers before towing.

NOTE: Visually inspect the flood light mounting yokes for loose hardware. This could prevent a broken fixture during towing.

SPECIFICATIONS

NOTE. In testing the Lister-Petter engine at the factory, the manufacturer uses an oil for moderate and low temperatures. This oil is specially formulated to assist in the break in period, and we would like it to be left in the engine for the first 100 hours. Additional information on fuel and lubrication specifications is found in the Lister Petter Industrial Engine Operators Handbook.

FUEL AND LUBRICATING OIL REQUIREMENTS					
OIL VISCOSITY					FUEL
STARTING	TEMPERATURE ON		MONOGRADE	MULTIGRADE	USA SPECIFICATION ASTM D-975-77
	° C	° F			
BELOW	-15	5	5W	5W/20	#1 Diesel Fuel
BETWEEN AND	-5 4	5 39	10W	10W/30	#1 Diesel Fuel
BETWEEN AND	4 50	39 86	20/20W	15W/40	#1 Diesel Fuel
ABOVE	30	86	30	15W/40 20W/40	#1 Diesel Fuel

See engine operator's handbook for further specifications. D-098

See the KUBOTA 905 EBG1 or 1105 EBG1 Engine Operators Handbook or the PERKINS 103-10 Engine Operators Handbook for information on oil and fuel requirements.

TOWING INSTRUCTIONS

Before towing the NIGHT-LITE 6330 the trailer should be inspected visually to insure that the following operations have been completed.

1. Hitch is securely attached to towing vehicle (safety chain secure).
2. All outriggers and jacks are retracted and secured.
3. Tower is lowered and the rear tower support pin is in place.
4. Light fixtures are positioned for transport.
5. Doors are closed and secure.
6. Check for adequate tire pressure.
7. Taillights are connected and operating (if equipped).
8. Ground rod is removed from ground and secured in the trailer

GROUND ROD INSTRUCTIONS

1. Remove ground rod stowed aside the left door (attached to the lower frame)
2. Unroll the electrical wire lead from the ground rod.
3. Attach the ground rod lead to the grounding lug located near the ballast compartment.
4. Drive the ground rod a minimum of 2 1/2 FT into the earth for adequate electrical grounding. If this is not possible consult your local qualified electrician.
5. **AFTER SHUTDOWN OF ENGINE:** Remove the ground rod from the earth, remove lead from the trailer ground lug and store ground rod inside left door.

SPECIFICATIONS

BEFORE STARTING

1. Fill the engine with the right grade of lubricating oil (see pg. 19) and to correct level (check dipstick).
2. Ensure there is an adequate supply of fuel.
3. Ensure **that the air cleaner is firmly attached**, the air canister seals and the hose clamps are properly sealed. Air cleaner element should be checked and replaced if necessary.
4. Install the ground rod.

DESCRIPTION OF OPERATION

By depressing the start assist switch, the fuel solenoid is energized. The solenoid plunger is drawn into the coil and activates the fuel control linkage to RUN position. When the engine starts, adequate engine oil pressure at the oil pressure switch will maintain the solenoid in the energized position. The start assist switch can be released as soon as the engine starts. A 10A inline fuse protects the solenoid from electrical damage.

LOW OIL PRESSURE SHUTOFF SYSTEM

Should a low oil pressure condition occur (less than 5 PSI), the pressure sending unit breaks the circuit between the battery and the fuel solenoid, allowing the spring load to immediately move the fuel control to the shutoff position.

HIGH COOLANT TEMPERATURE SHUTOFF SYSTEM

Should a high coolant temperature condition occur, the temperature sending unit breaks the circuit between the battery and the fuel solenoid, allowing the spring load to immediately move the fuel control to the shutoff position.

STARTING/STOPPING INSTRUCTIONS

STARTING THE LISTER PETER ENGINE

NOTE: LPW-3 Lister includes a glow plug and cold start system controlled by the start assist switch on the control panel. This switch also activates the fuel solenoid for quick starts. Use the switch routinely during engine starts.

1. Turn ON/OFF toggle switch to the up (ON) position.
2. Depress preheat, start-assist switch engaging the fuel solenoid and powering the glow plug. Hold in until step 3 (next column) has been completed

NOTE: At temperatures below 30 F. depress the preheat switch for approximately one minute before going on to step 3.

3. Depress start switch until the engine fires. Release start assist switch and start switch as soon as the engine starts.

NOTE: To prevent equipment damage, do not hold start switch in for more than 10 seconds. Allow cool down time between cranking intervals.

STOPPING THE LISTER PETER ENGINE

1. Turn ON/OFF toggle switch to the down (OFF) position.

STARTING THE KUBOTA AND PERKINS ENGINES

NOTE: The Kubota and the Perkins engines includes a glow plug cold start system controlled by the ignition switch on the control panel. Glow plugs are not needed on a warm engine or if the ambient temperature is above 50 F. Do not use starting fluid or ether.

1. Turn the ignition switch to the **PREHEAT** position and hold until the glow plug lamp goes out.
2. Turn the ignition switch to the Start position until the engine starts. Release key as soon as the engine starts.
3. If engine fails to start it may be necessary to cycle the glow plugs again.

NOTE: To prevent equipment damage, **DO NOT hold ignition switch for more than 10 seconds in the start position. If the engine does not start in 10 seconds, wait 30 seconds and try the start sequence again. Do not run the cell motor for more than 20 seconds continuously. Limit engine cranking to 3 attempts with a 2 minute cool-down between each. After 3 attempts allow to cool to ambient temperature.**

STOPPING THE KUBOTA AND PERKINS ENGINES

1. Turn the ignition switch to the OFF position. This breaks the circuit between the battery and the fuel solenoid, allowing the spring load to immediately move the fuel control to the shutoff position.
2. Disconnect the ground rod.

MODEL AND SERIAL NUMBERING SYSTEM

SERIAL NUMBER LOCATION

Trailer: All **NIGHT-LITE 6330** models have a serial number plate located just below the rear tower support on the rear panel.

Generator: Plate attached to the side of the generator housing.

Engine: Plate attached to the engine.
LPW – 3 Top of intake manifold.

KUBOTA D905-BG and D1105-BG
Left side, between
manifold and starter.

ISUZU 3LB1 and PERKINS 103-10:
Upper right front corner behind injector
pump

DESCRIPTION OF MODELS AND OPTIONS

The **NIGHT-LITE 6330** light tower uses four 1000 Watt Metal Halide lamps with the exclusive Allmand SHO lighting system to produce a total of 334,204 lumens (83,551 lumens per fixture). Optional reflective visors and 6-light units are available. The lights are mounted on either a manual winch or electric winch tower. The manual tower is operated by two hand crank winches. One winch, mounted on the trailer frame, erects the mast from the horizontal towing position to vertical. The second winch, mounted on the tower, extends the mast vertically to the desired height. The second tower is operated by a 120V electric winch located inside the trailer housing. The electric winch erects the mast from horizontal to vertical and by releasing a lock handle extends the mast vertically to the desired height. The tower power cords are available as either straight cord or a cord reel. Inside fixture storage is offered for the 4-light option.

The heavy duty trailer shell has 12 gauge doors and roof panels. The shell houses the 15" wheels and tires inside the side panels. The front panels are rust proof ABS plastic. The **NIGHT-LITE 6330** light tower is powered by either a Lister Petter LPW-3 16.5 hp water cooled engine, one of two Kubota water cooled engines, 10.5 hp or 13.6 hp., or an Isuzu water cooled 16 hp diesel engine. Each engine mounts to either the 6KW or 8KW generator. The trailer houses a 50 gallon poly fuel tank and an optional sound attenuation package.

SPECIFICATIONS

ELECTRICAL

Hard wired electrical circuits
Easily serviceable componentized ballast assemblies.
Ground rod.
Hour meter.
Voltmeter (optional)
External 120V and 240V outlets (optional).

FLOOD LIGHT ASSEMBLY

Four or six 1000 watt lamp fixtures sealed for all weather use. Lamps can be either the SHO 1000 fixture, 1250 watt fixture or PowerLite fixture.

SHO 1000 FIXTURE - BT-37 lamp, Metal Halide, Laboratory rated life is 10,000 hours.

Lumen rating: 110,000
Warm-up time: 2-4 minutes
Restart time: 10-15 minutes

POWERLITE FIXTURE = BT=56 1000 watt Multi-Vapor lamp, Metal Halide, Laboratory rated life is 12,000 hours.

Lumen rating: 110,000
Warm-up time: 2-4 minutes
Restart time: 10-15 minutes

POWERLITE FIXTURE - E-25 1000 watt High Pressure Sodium lamp (often referred to as H.P.S), Laboratory rated life is 24,000 hours.

Lumen rating: 140,000
Warm-up time: 4-6 minutes
Restart time: 1 minute

NOTE: A trailer equipped with Metal Halide lights and a trailer equipped with High Pressure Sodium lights use different ballasts and starters. Therefore, it is not advisable to interchange bulb types.

MAST

Three-section steel tube mast, which extends to 30 feet. The mast is extended with either two manual winches or one Dutton-Lainson electric winch. The assembly includes self-lubricating nylon guide rollers and 360° rotating light bar.

TRAILER

The complete generator is housed in a lockable enclosure with the frame fabricated from heavy gauge steel mounted on a two-wheel, leaf spring axle.

The design enables the trailer to contain the outriggers in a simple compact position.

When the mast is in the operating position it is located in the middle of a four point outrigger system for optimum balance and stability. This system was engineered to allow the light plant to remain operational in sustained winds of 65 MPH with the mast extended to full height and the outriggers in position.

The design includes an adjustable-height reversible hitch, which includes a 2" ball and pintle hook hitch.

STABILIZERS

Four (4) point outrigger design. with tower center mounted between two (2) retractable side outriggers, tongue and rear jack.

SPECIFICATIONS

NIGHT-LITE 6330 DIMENSIONS

Height lowered:	6'6" (1.98 m)
Height extended:	30' (9.14 m)
Length:	14'9" (4.49 m)
Width:	6'4" (1.92 m)
Outrigger width:	11'6" (3.5 m)
Trailer:	Structural steel frame Leaf spring axle
Wheels & tires:	15"

FUEL AND LUBRICATING OIL

The temperatures mentioned in the table are the ambient temperatures at the time the engine is started.

However, if the running ambient temperatures are much higher than the starting temperatures, a compromise must be made and a higher viscosity oil used (provided starting is satisfactory). Multigrade oils overcome the problem, provided they have a suitable specification.

DOMESTIC SHIPPING WEIGHT

Fixtures:	15 lbs. ea. = 60 lbs.
Trailer with mast:	1,990 lbs. (902.7 kg)
Total weight:	2,050 lbs. (929.9 kg)

SPECIFICATIONS

LPW-3 ENGINE

LISTER LPW-3 Alpha Series, direct injection 3 Cylinder

Displacement:	85.13 cu. (1396.13 cc)
Bore:	3.38 in. (8.6 cm)
Stroke:	3.15 in.(8.0 cm)
Power output:	16.5 BHP continuous
Power output derating:	3.5% for every 1000 ft altitude (305 m) above sea level
Air inlet temp:	2% per 10°F (5.6C) above 85° F(29.4C)
Fuel:	Diesel
Fuel consumption:	1.25 ga (4.7L/hr) at less than 75%load
Oil sump capacity (excluding filter):	4.0 US qt. (3.8L)
Starting:	12 volt electric

Low oil pressure shutdown, high engine temp. shutdown, and glow plug cold start assist are standard.

KUBOTA D 1105-EBG1 ENGINE

Kubota D1105-EBG1, indirect injection 3 Cylinder

Displacement:	68.53 cu. (1.1 cm)
Bore:	3.07 in. (78 mm)
Stroke:	3.09 in. (78.4 mm)
Power output:	13.6 @ 1800 rpm
Power output derating:	3.0% for every1000 ft. altitude (305 m) above 360 ft.
Ambient temp:	1% per 10°F (5.6°C) above 77°F (25°C)
Fuel:	Diesel
Fuel consumption:	.63 gal (2.39 L)/hr
Starting:	Glow plugs needed below 45 F. 12V electric
Oil sump capacity (excluding filter):	5.4 US qt. (5.14 L)

Low oil pressure shutdown, high engine temp. shutdown, and glow plug cold start assist are standard.

KUBOTA D905-EBG1 ENGINE

Kubota D905-EBG1, indirect injection 3 Cylinder

Displacement:	54.80 cu. in.(898 cm)
Bore:	2.83 in. (72 mm)
Stroke:	2.90 in. (73.6 mm)
Power output:	10.5 BHP@ 1800 rpm
Power output derating:	3.0% for every1000 ft. altitude (305 m) above sea level
Ambient temp:	1% per 10° F (5.6°C) above 77°F (25°C)
Fuel:	Diesel
Fuel consumption:	0.63 US gal (2.39 L/hr)
Starting:	Glow plugs needed below 45' F. 12V electric
Oil sump capacity (excluding filter)	5.40 US qt. (5.14L)

Low oil pressure shutdown, high engine temp. shutdown, and glow plug cold start assist are standard.

PERKINS 103.10 ENGINE

Perkins 103.10, Indirect injection 3 Cylinder

Displacement:	58.3 cu. in. (954 cc)
Bore:	75 mm
Stroke:	72 mm
Power output:	10.7 BHP@ 1800 RPM
Power output derating:	3.5% for every 1000 ft altitude (305 m) above sea level
Air Inlet Temp:	1% per 10°F (5.6C) above 77° F (25°C)
Fuel:	Diesel
Oil sump capacity:	Fill to correct level
Starting:	12 volt electric

Low oil pressure shutdown, high engine temp. shutdown, and glow plug cold start assist are standard.

CONTROLS AND COMPONENTS

NOTE: COMPONENTS SHOWN ARE STANDARD. PICTURES MAY VARY WITH DIFFERENT OPTIONS.



FIGURE 1

FIGURE 2

FIG. 1. A.C. CONTROL PANEL

1. Switch, Circuit Breaker (Lights 1 through 4)
2. Switch, Circuit Breaker (240V Receptacle)
3. Switch, Circuit Breaker (120V Receptacles)



SAFETY WARNING

FAILURE TO UNDERSTAND AND COMPLY WITH SAFETY RELATED INFORMATION AND INSTRUCTIONS MAY RESULT IN INJURY TO THE OPERATOR OR OTHERS. IF YOU DO NOT UNDERSTAND ANY PART OF THIS CONTACT YOUR DEALER FOR CLARIFICATION PRIOR TO OPERATING EQUIPMENT.

FIG. 2. D.C. CONTROL PANEL

4. Voltmeter (optional)
Indicates charging circuit voltage
5. Hour Meter
Shows total elapsed hours of engine operation.
6. Momentary Contact Switch (Electric Winch Model)
Lift up to raise and extend the tower.
Press down to lower and fold the tower.
7. Ignition ON/OFF Switch
8. Start Assist Switch
Push to activate fuel solenoid and glow plug prior to and while depressing start switch.
9. Start Switch
Push to start.
10. 1.5 AMP Circuit Breaker (Electric Winch Model)

CONTROLS AND COMPONENTS

NOTE: COMPONENTS SHOWN ARE STANDARD. PICTURES MAY VARY WITH DIFFERENT OPTIONS.

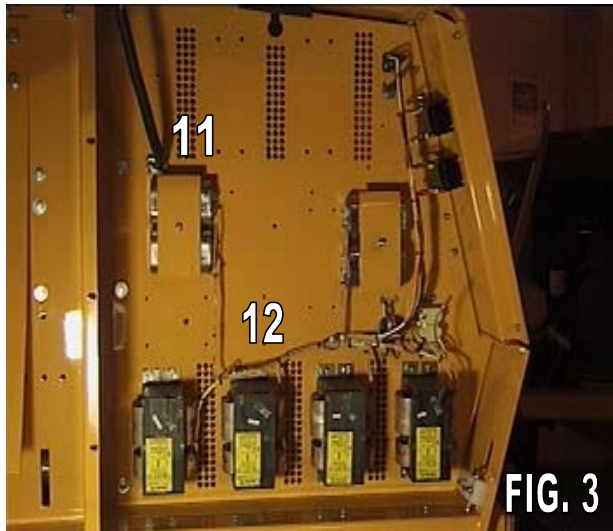

FIG. 3 BALLAST PANEL

- 11. Ballast, Capacitors 1 through 4
- 12. Ballast, Transformers 1 through 4



FIG. 4 CONVENIENCE PANEL

- 13. 120 Volt/ 15 Amp Outlet Receptacles (Ground fault)
- 14. 240 Volt/ 15 Amp D.C. Outlet Receptacle
- 15. Power Cord Access Hole



SAFETY WARNING

FAILURE TO UNDERSTAND AND COMPLY WITH SAFETY RELATED INFORMATION AND INSTRUCTIONS MAY RESULT IN INJURY TO THE OPERATOR OR OTHERS. IF YOU DO NOT UNDERSTAND ANY PART OF THIS CONTACT YOUR DEALER FOR CLARIFICATION PRIOR TO OPERATING EQUIPMENT

CONTROLS AND COMPONENTS

NOTE: COMPONENTS SHOWN ARE STANDARD. PICTURES MAY VARY WITH DIFFERENT OPTIONS.



FIG. 5 GROUND ROD

16. Ground Rod

Ground rod should be attached to grounding lug with wire provided and ground rod and then driven fully into the earth for adequate electrical ground, as required by local, state, or national electrical code.

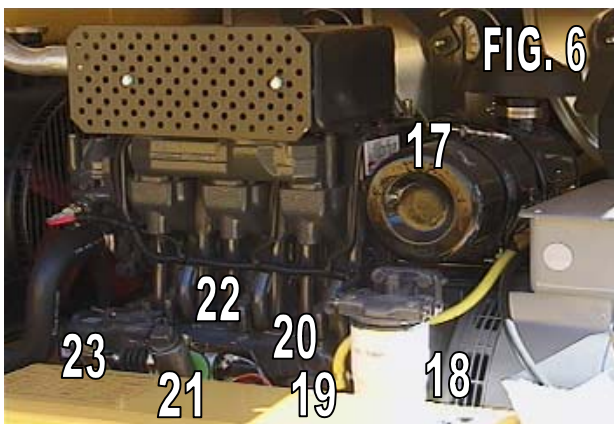

FIG. 6 ENGINE (Left Side)

17. Air Cleaner

18. Fuel Filter

19. Fuel Lift Pump

20. Fuse (10 Amp)

21. Oil fill

22. Stop Solenoid

23. Oil Filter

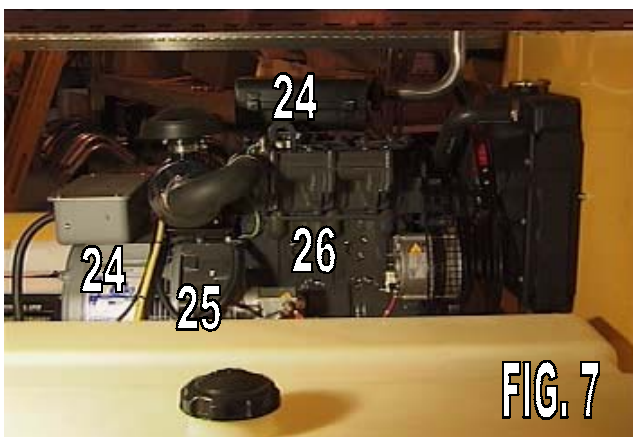

FIG. 7 ENGINE (Right Side)

24. Fuel Return Line

25. Fuel Suction Line

26. Starter

27. Glow Plug

CONTROLS AND COMPONENTS

NOTE: COMPONENTS SHOWN ARE STANDARD. PICTURES MAY VARY WITH DIFFERENT OPTIONS.



FIG. 8 REAR JACK

28. RearJack



SAFETY WARNING

**WHEN EXTENDING REAR JACK,
WATCH TO INSURE YOU ARE
CLEAR OF THE OVERHANGING
ENDS OF THE MAST BEFORE**

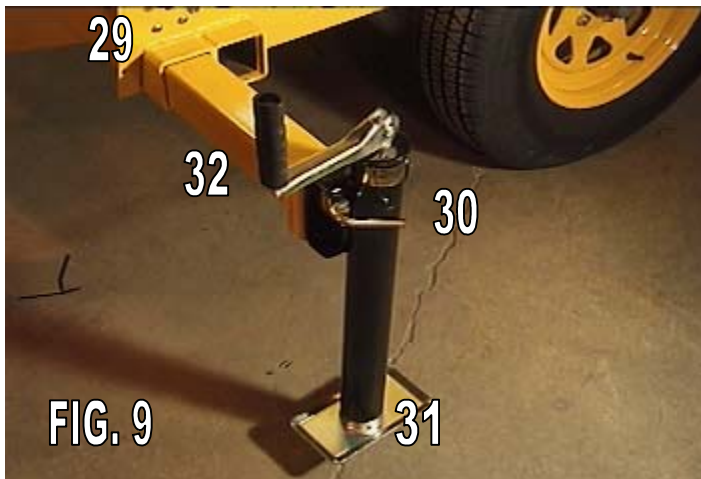

FIG. 9 OUTRIGGER JACK

29. Pin--Retains outrigger in retracted position for towing

30. Jack Pin--Pull to allow jack to rotate

31. Outrigger Jack

32 Jack Handle--Crank handle to raise and lower foot of jack to level trailer.



FIG. 10 REAR TOWER SUPPORT

33. Pin—Locks tower into rear tower support

34. Rear Tower Support

CONTROLS AND COMPONENTS

NOTE: COMPONENTS SHOWN ARE STANDARD. PICTURES MAY VARY WITH DIFFERENT OPTIONS.

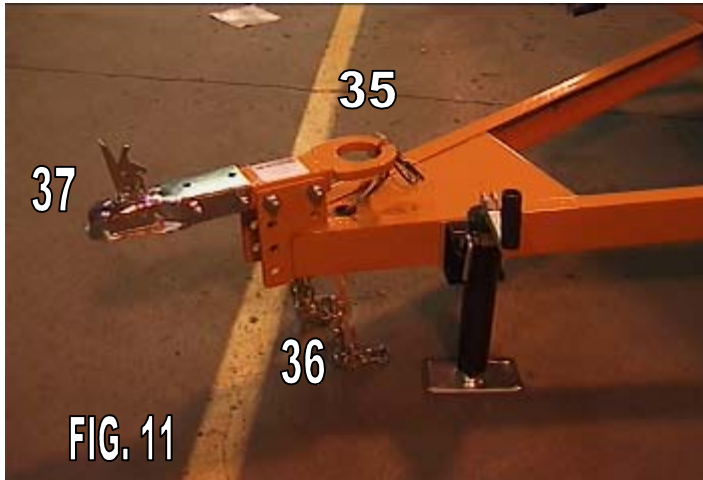

FIG. 11 TONGUE ASSEMBLY

- 35. Taillight Wiring Harness
- 36. Safety Tow Chains
- 37. Reversible Hitch (2" Ball and Pintle Hitch)

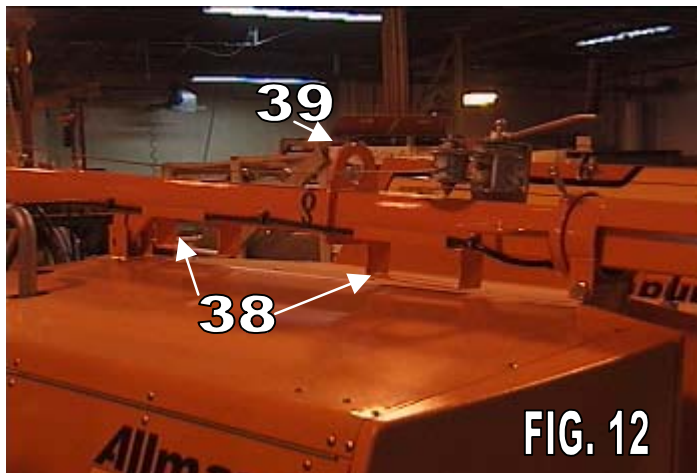

FIG. 12 FORKLIFT POCKETS

- 38. Forklift Pockets
- 39. Lifting Eye

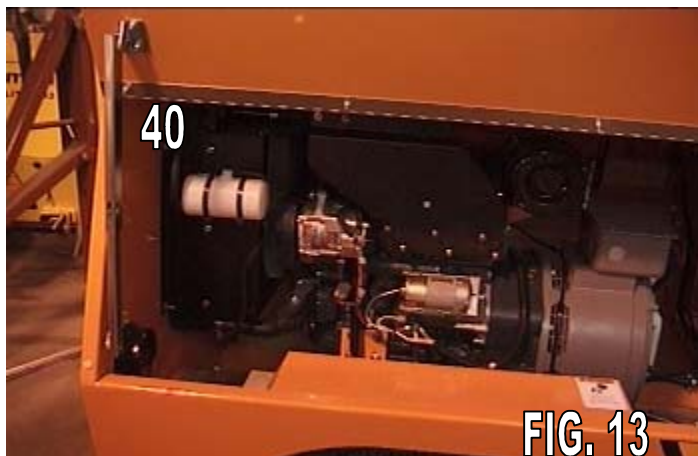

FIG. 13 DOOR PROP

- 40. Door Prop—Locks Door Panel in Open Position

CONTROLS AND COMPONENTS

NOTE: COMPONENTS SHOWN ARE STANDARD. PICTURES MAY VARY WITH DIFFERENT OPTIONS.

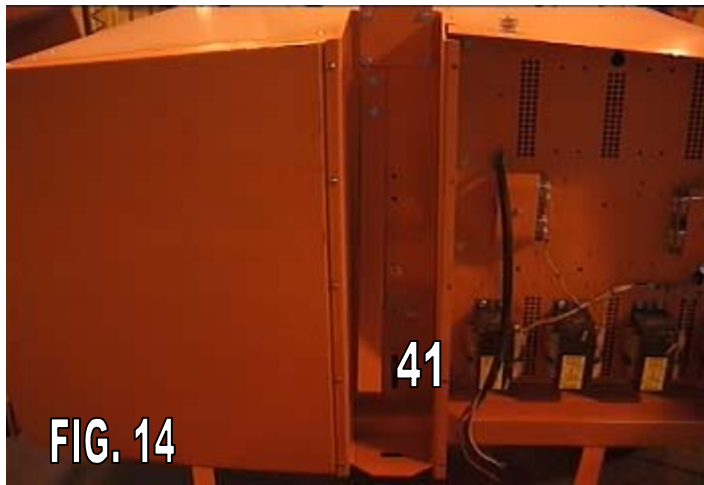

FIG. 14 KICKOUT SPRING

41. Kickout Spring—*Tilts mast off center when folding mast down*

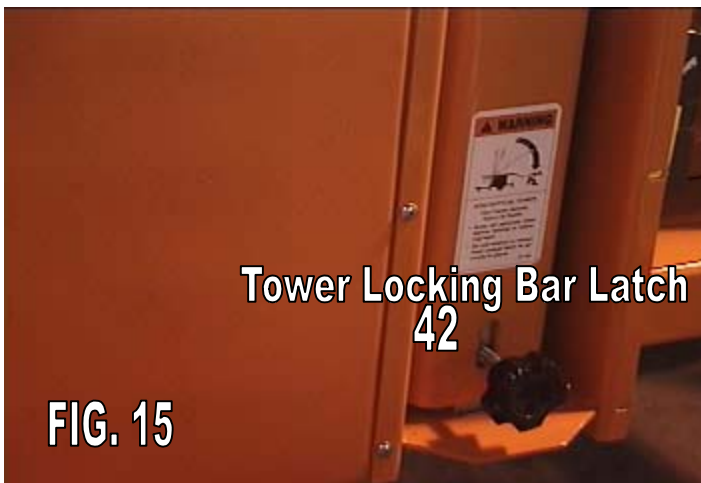

FIG. 15 TOWER LOCKING BAR LATCH

42. Mast Locking Bar Latch --*Locks mast in vertical position and allows tower to rotate.*

NOTE: *Tower must be positioned with the two black triangles on the tower assembly, near the mast handles, pointing at each other. Then the locking bar can be released from the strike plate allowing the tower to rotate toward horizontal towing position.*



FIG. 16 MANUAL WINCH HANDLE

43. Winch Handle--*Use to raise and fold mast.*

CONTROLS AND COMPONENTS

NOTE: COMPONENTS SHOWN ARE STANDARD. PICTURES MAY VARY WITH DIFFERENT OPTIONS.

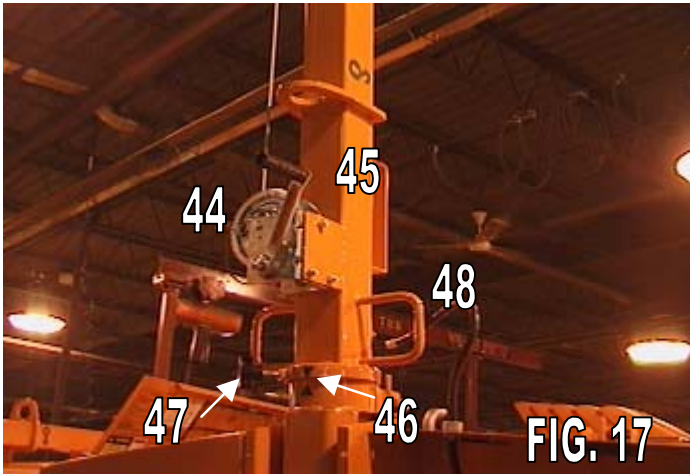

FIG. 17 TOWER CONTROLS

- 44. Manual Winch —*Use to extend and lower mast..*
- 45. Tower Winch Handle
- 46. Alignment Arrows—*Must be aligned to unlock the tower.*
- 47. Lock Knob—*Locks tower in position.*
- 48. Mast Handles—*Use to rotate tower and lights.*



FIG. 18 Cord Reel

- 49. Cord reel —*Available on either Electric or Manual winch models*

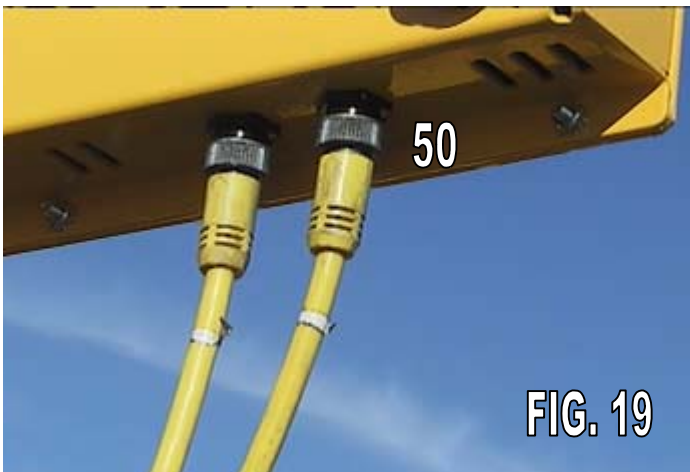

FIG. 19 Cord Reel

- 50. Lamp Connector Lead—*For quick connecting/disconnecting of the lamp fixtures*

CONTROLS AND COMPONENTS

NOTE: COMPONENTS SHOWN ARE STANDARD. PICTURES MAY VARY WITH DIFFERENT OPTIONS.

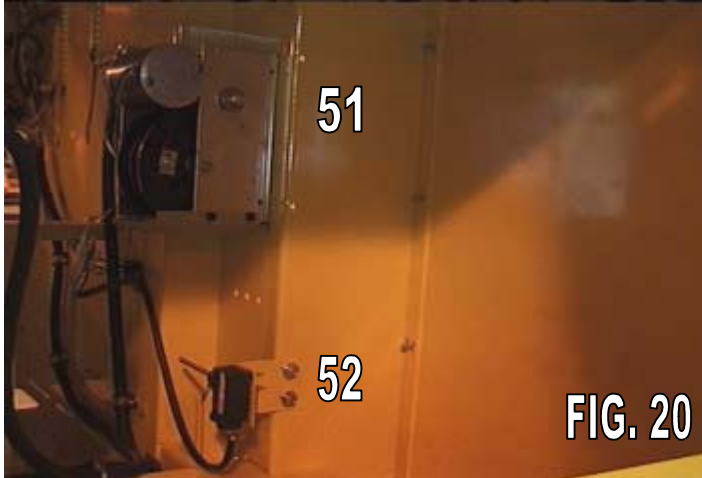

FIG. 20 Electric Winch

- 51. Dutton-Lainson Strong Arm Winch—Used to raise and extend, lower and fold mast.
- 52. Slack Limit Switch—Shuts off winch when cable slack is sensed by sensor arm.

NOTE: See pages 10-11, Strong Arm Electric Winch Mast Operation, for correct operating procedures.



FIG. 21 Electric Mast

- 53. Mast Handle—Use to rotate mast.
- 54. Lock Handle—Pull to unlock tower sections when raising tower.
- 55. Lock Pin—Prevents accidental release of lock when rotating mast.

ROUTINE MAINTENANCE SCHEDULE

LISTER-PETTER LPW-3 INSPECTION AND LUBRICATION SCHEDULE

Check condition of the steel cable and make sure it is properly secured. Check hydraulic fluid level.

Lubrication grease specifications: N.G.L.I. consistency #2, high temperature anti-friction bearing lubricating grease.

Service intervals shown below have been established for operation under normal conditions. Where equipment is operated under severe conditions (very dusty, extreme heat or cold, etc.) affected items should be serviced more frequently.

INTERVAL	ITEM	PROCEDURE
Daily or 10 Hr.	Fuel level	Check and fill as necessary.
	Lubricating oil	Check level and condition.
	Air Cleaner	Clean under very dusty conditions.
125 Hr.	All 10 Hr. items	As above
	Air Cleaner	Change element if necessary or clean under moderately dusty conditions.
	Battery	Check level of electrolyte.
	Engine Generator assembly	Check for fuel and lubricating oil leaks.
250 Hr.	All 125 Hr. items	As above
	Engine lubricating oil system	Drain lubricating oil, flush out system, renew filter element and refill with correct grade and type oil.
	Fuel Injector Nozzles	Clean if the exhaust is dirty
	Fuel Filter	Renew filter element if fuel not perfectly clean.
500 Hr.	All 250 Hr. Items	As above
	Fuel Filter	Renew filter element.
1000 hr. or yearly	All 500 Hr. Items	As above
	Engine Service	Decarbonize if the engine shows loss of compression or blow-by past the piston. Do not disturb otherwise.
	Engine Valves	Adjust clearance.
	Engine Service	Clean the cylinder and cylinder head finning under dusty conditions if necessary.
	Cable pulley at the bottom of the front mast support	Remove, clean, and grease.
	Cable pulleys on mast	Inspect for wear. Clean and lubricate.
	Axle wheel bearings	Clean and repack.
	Fuel System	Clean sediment from tank.

ROUTINE MAINTENANCE SCHEDULE

KUBOTA D905 and D1105 and PERKINS 103-10

INSPECTION AND LUBRICATION SCHEDULE

Check condition of the steel cable and make sure it is properly secured. Check hydraulic fluid level.

LUBRICATION GREASE SPECIFICATIONS:

N.G.L.I. consistency #2, high temperature anti-friction bearing lubricating grease.

Service intervals shown below have been established for operation under normal conditions. Where equipment is operated under severe conditions (very dusty, extreme heat or cold, etc.) affected items should be serviced more frequently.

KUBOTA AND ISUZU

INTERVAL	ITEM	PROCEDURE
Daily or 10 Hr.	Fuel level	Check and fill as necessary
	Lubricating oil	Check level and condition
100 Hr.	All 10 Hr. items	As above
	Air Cleaner	Service as required. Service requirements may be accelerated
	Battery	Check level of electrolyte
	Engine Generator assembly	Check for fuel and lubricating oil leaks
200 Hr.	All 100 Hr. items	As above
	Engine lubricating oil system	Drain lubricating oil, flush out system, renew filter element and refill with correct grade and type oil
400 Hr.	Coolant	Check level and condition
	Fuel Filter	Replace with new.
500 Hr.	All 200 Hr. Items	As above
	Fan belt	Check tension and condition
	Radiator	Clean out fins with water or air
1000 hr. or yearly	All 500 Hr. Items	As above
	Engine Valves	Adjust clearance
	Cable pulley at the bottom of the front mast support	Remove, clean, and grease
	Cable pulleys on mast	Inspect for wear. Clean and lubricate
	Axle wheel bearings	Clean and repack
	Fuel System	Clean sediment from tank

PERKINS ONLY

Every Day or every 8 hours	First Service - (20/50 hours)	Every 100 hours or 3 months	Every 200 hours or 6 months	Every 400 hours or 12 months	Every 600 hours or 18 months	
●	●	●	●	●	●	Check level of coolant (Top up with coolant only)
					●	Check concentration of coolant
					●	Renew Coolant (FILL SLOWLY, ENSURE CORRECT QUANTITY IS USED)
		●			●	Check engine lubricating oil level
		●			●	Renew engine oil (FILL SLOWLY, ENSURE CORRECT QUANTITY IS USED)
		●			●	Renew engine oil filter
		●			●	Drain water from fuel filter and pre-filter
		●			●	Renew fuel filter canister (N.B. Air vent screws on filter and fuel pump)
	●				●	Check tension of alternator drive belt
	●				●	Check alternator drive belt for wear
	●				●	Renew alternator drive belt
		●			●	Check and adjust Idle speed
		●			●	Tighten cylinder head
		●			●	Check and adjust valve clearances
		●			●	Check electrical systems
		●			●	Check all nuts/bolts for tightness
		●			●	Check injectors for performance
		●			●	Clean air filter (earlier check may be necessary)
	●				●	Renew air filter element
	●				●	Check and correct any leaks or engine damage

TROUBLESHOOTING



SAFETY WARNING

DANGER!

HIGH VOLTAGE! DO NOT ATTEMPT TO TEST AND REPAIR GENERATOR AND BALLAST ELECTRICAL SYSTEMS UNLESS YOU UNDERSTAND AND ARE QUALIFIED TO WORK ON SUCH SYSTEMS.

When one lamp does not light, **TURN OFF THE GENERATOR** and test the lamp by switching leads with a lamp that **DOES** light. **DO NOT WEAR JEWELRY WHILE WORKING WITH ELECTRICITY!** If the following procedures do not solve your problem, have the circuit tested by a licensed electrician. **DO NOT** attempt to test generator voltage or ballast electrical systems unless you are a qualified electrician. Consult the factory for voltage specifications and test procedures

PROBLEM	POSSIBLE CAUSE
ONE OR MORE LIGHTS DO NOT LIGHT UP.	1. Circuit breakers in the outlet box are not turned on or have tripped.
	2. Lamps are not allowed time to cool after last being lit. You must allow 15 minutes between the time the lights are shut off and the time they are restarted.
	3. The lam or lamps are burned out or broken.
	4. One or more of the lamps are not screwed in securely.
	5. Plug and socket at light bar not securely pushed together and locked.
	6. The temperature of the ballast is below -20 degrees F. the efficiency of the capacitors in the ballast is not enough to ignite the lamps. For operations where the temperatures of the ballasts falls below -20 degrees F. some means of warming the ballast must be used.
	7. Low electrical system voltage.
	8. A loose connection in the back of the lamp socket in the lamp holder.
	9. A circuit breaker or breakers are defective.
	10. A loose connection on the terminal board.
	11. The engine and generator are not running up to speed (1800 RPM)
	12. A wrong style replacement lamp (requiring a different ballast) has been installed.
	13. Too much power is being drawn from the auxiliary outlets.
	14. Capacitor or transformer have failed.
	15. Corrosion has occurred on the lamp bases.